

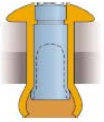

Magna-Lok

One-piece self-locking blind fastener with circle-seal lock for high vibratory situations. Wide grip range for reduced inventory. Available in aluminium, steel, and stainless steel, high shear and tensile strength, good sealing properties.



Magna-Bulb

One-piece self-locking, bulbing blind fastener, wide grip range. High shear and tensile strength, vibration resistant. Ideal for thin or low strength materials plastic, aluminium, fibreglass.



Hucktainer

Two-piece fastener specifically for joining GRP board to frame. Does not crush or damage, wide grip range, low profile gives neat tamper-proof finish. Seal prevents moisture ingress.



Bom

Structural high strength blind steel fastener. Excellent pull-together properties, high clamping force.



Magna-Grip

A unique two piece fastener with a wide grip range and high resistance to vibratory loosening, that breaks flush with the collar every time. Consistent high clamp force. Available in a variety of head styles.

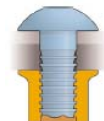

LH-224

Aluminium bodied, air operated hand held tool. Installs all Huck Fasteners up to 1/4" diameter. Lightweight (2.5kg) medium duty production tool. Requires 90 - 100 lb PSI air (1bar) Air consumption 7 CFM.



256

The high speed 256 production tool features optimum stroke for one-cycle installation and has a pull piston for improved service life and ease of maintenance. Factory tested for 2,000 cycles, the 256 has chrome plated piston rods to extend the life of the seals. Requires 90 - 100 lb PSI air (6.2-7.59bar) Air consumption 30 CFM. Installs Magna-Lok 3/8", Bom 1/4" & 5/16", Magna-Grip 5/16" & 3/8"



2580

The 2580 Hydraulic Powered Installation tool is a lightweight tool for use in a wide range of high-speed production applications. With only one moving part, the tool provides for increased reliability and requires minimal maintenance. Installs Magna-Lok 3/8", Bom 1/4", 5/16" & 3/8" Magna-Grip 5/16" & 3/8"



HK3413

The HK3413 Powerig provides lightweight portable hydraulic power for all Huck installation Tools. The strong tubular frame makes for easy manual handling and provides protection for main components when used in rugged conditions. It also features a built in pressure gauge and large oil filter for the hydraulic system. The Powerig automatically starts when the installation Tool trigger is activated and stops when the installation Tool cycle is complete.



STRUCTURAL FASTENERS



MAGNA-LOK

BLIND FASTENER MADE IN THE USA

Fastener Specifications and Grip Data

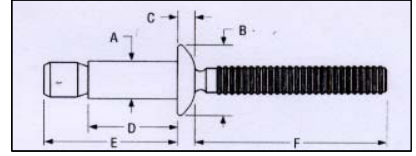

| FASTENER CODE | LIST PRICE PER 100 \$ | A | B | DIA | | DRILL SIZE | TYPICAL IN SHEAR | INSTALLED VALUES | | | GRIP RANGE MM | C | D | E | F |
|---------------|-----------------------|---|---|------|----|------------|------------------|------------------|------|---------|---------------|---|---|---|---|
| | | | | INCH | MM | | | NOMINAL | GRIP | TENSILE | | | | | |

PROTRUDING HEAD STEEL

| | | | | | | | | | | | | | | |
|--------------|--|------|-------|-------|-----|-------|-------|-------|------|---------------|------|-------|-------|-------|
| MGLP-R6-4 | | 4.78 | 9.78 | 3/16" | 4.8 | 5.0 | 5783 | 4448 | 667 | 1.57 - 6.86 | 2.16 | 10.54 | 17.15 | 25.40 |
| MGLP-R6-E | | 4.78 | 9.78 | 3/16" | 4.8 | 5.0 | 5783 | 4448 | 667 | 1.57 - 11.10 | 2.16 | 14.53 | 24.13 | 25.40 |
| MGLP-R8-6 | | 6.43 | 13.34 | 1/4" | 6.4 | 17/64 | 11121 | 8229 | 1334 | 2.03 - 9.53 | 2.97 | 14.22 | 24.64 | 25.40 |
| MGLP-R8-E | | 6.43 | 13.34 | 1/4" | 6.4 | 17/64 | 11121 | 8229 | 1334 | 2.03 - 15.88 | 2.97 | 20.57 | 35.69 | 25.40 |
| MGLP-R8-E126 | | 6.43 | 13.34 | 1/4" | 6.4 | 17/64 | 11121 | 8229 | 1334 | 6.22 - 20.00 | 2.97 | 24.76 | 39.87 | 25.40 |
| MGLP-R8-18 | | 6.43 | 13.34 | 1/4" | 6.4 | 17/64 | 11121 | 8229 | 1334 | 21.08 - 28.75 | 2.97 | 33.27 | 43.68 | 25.40 |
| MGLP-R12-12 | | 9.8 | 19.99 | 3/8" | 9.5 | 10.0 | 26689 | 17793 | 2669 | 3.05 - 14.22 | 4.45 | 21.34 | 41.91 | 39.24 |

ALUMINIUM

| | | | | | | | | | | | | | | |
|-------------|--|------|-------|-------|-----|-------|-------|------|------|--------------|------|-------|-------|-------|
| MGLP-B6-E | | 4.78 | 9.78 | 3/16" | 4.8 | 5.0 | 2669 | 2224 | 334 | 1.57 - 11.10 | 2.16 | 14.53 | 24.13 | 25.40 |
| MGLP-B8-6 | | 6.43 | 13.34 | 1/4" | 6.4 | 17/64 | 5783 | 3959 | 445 | 2.03 - 9.53 | 2.97 | 14.22 | 24.64 | 25.40 |
| MGLP-B8-E | | 6.43 | 13.34 | 1/4" | 6.4 | 17/64 | 5783 | 3959 | 445 | 2.03 - 15.88 | 2.97 | 20.57 | 35.69 | 25.40 |
| MGLP-B12-12 | | 9.8 | 19.99 | 3/8" | 9.5 | 10.0 | 13122 | 8452 | 1112 | 3.05 - 14.22 | 4.45 | 21.34 | 41.91 | 39.24 |

STAINLESS STEEL

| | | | | | | | | | | | | | | |
|------------|--|------|-------|-------|-----|-------|-------|------|-----|--------------|------|-------|-------|-------|
| MGLP-U6-4 | | 4.78 | 9.78 | 3/16" | 4.8 | 5.0 | 5783 | 4226 | 445 | 1.57 - 6.86 | 2.16 | 10.54 | 17.15 | 25.40 |
| MGLP-U6-7 | | 4.78 | 9.78 | 3/16" | 4.8 | 5.0 | 5783 | 4226 | 445 | 5.44 - 11.10 | 2.16 | 14.53 | 20.96 | 25.40 |
| MGLP-U8-6 | | 6.43 | 13.34 | 1/4" | 6.4 | 17/64 | 10453 | 8006 | 890 | 2.03 - 9.53 | 2.97 | 14.22 | 24.64 | 25.40 |
| MGLP-U8-10 | | 6.43 | 13.34 | 1/4" | 6.4 | 17/64 | 10453 | 8006 | 890 | 8.89 - 15.88 | 2.97 | 20.57 | 30.99 | 25.40 |

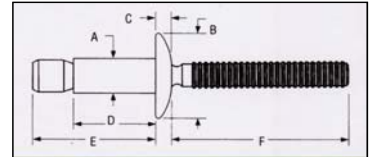

TRUSS HEAD

STEEL

| | | | | | | | | | | | | | | |
|-----------|--|------|------|-------|-----|-----|------|------|-----|--------------|------|-------|-------|-------|
| MGLT-R6-4 | | 4.75 | 12.7 | 3/16" | 4.8 | 5.0 | 5783 | 4448 | 667 | 1.57 - 6.86 | 2.16 | 10.54 | 17.15 | 25.40 |
| MGLT-R6-E | | 4.75 | 12.7 | 3/16" | 4.8 | 5.0 | 5783 | 4448 | 667 | 1.57 - 11.10 | 2.16 | 14.53 | 24.13 | 25.40 |

ALUMINIUM

| | | | | | | | | | | | | | | |
|-----------|--|------|------|-------|-----|-----|------|------|-----|--------------|------|-------|-------|-------|
| MGLT-B6-7 | | 4.75 | 12.7 | 3/16" | 4.8 | 5.0 | 2669 | 2224 | 334 | 5.44 - 11.10 | 2.16 | 14.53 | 20.96 | 25.40 |
|-----------|--|------|------|-------|-----|-----|------|------|-----|--------------|------|-------|-------|-------|

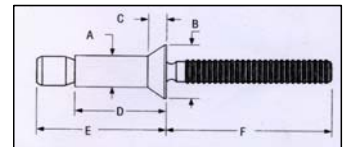

100 COUNTERSUNK HEAD STEEL

| | | | | | | | | | | | | | | |
|--------------|--|------|-------|-------|-----|-------|-------|------|------|---------------|------|-------|-------|-------|
| MGL100-R6-6 | | 4.78 | 8.76 | 3/16" | 4.8 | 5.0 | 5783 | 4448 | 667 | 3.18 - 8.41 | 1.78 | 12.34 | 19.35 | 25.40 |
| MGL100-R8-8 | | 6.53 | 10.29 | 1/4" | 6.4 | 17/64 | 11121 | 8229 | 1334 | 4.06 - 12.07 | 2.01 | 16.76 | 26.90 | 25.40 |
| MGL100-R8-12 | | 6.53 | 10.29 | 1/4" | 6.4 | 17/64 | 11121 | 8229 | 1334 | 10.54 - 18.42 | 2.01 | 23.11 | 33.25 | 25.40 |

ALUMINIUM

| | | | | | | | | | | | | | | |
|--------------|--|------|-------|-------|-----|-------|------|------|-----|---------------|------|-------|-------|-------|
| MGL100-B6-6 | | 4.78 | 8.76 | 3/16" | 4.8 | 5.0 | 2669 | 2224 | 334 | 3.18 - 8.41 | 1.78 | 12.34 | 19.35 | 25.40 |
| MGL100-B8-8 | | 6.53 | 10.29 | 1/4" | 6.4 | 17/64 | 5783 | 3959 | 445 | 4.06 - 12.07 | 2.01 | 16.76 | 26.90 | 25.40 |
| MGL100-B8-12 | | 6.53 | 10.29 | 1/4" | 6.4 | 17/64 | 5783 | 3959 | 445 | 10.54 - 18.42 | 2.01 | 23.11 | 33.25 | 25.40 |

STAINLESS STEEL

| | | | | | | | | | | | | | | |
|-------------|--|------|-------|------|-----|-------|-------|------|-----|--------------|------|-------|-------|-------|
| MGL100-U8-8 | | 6.53 | 10.29 | 1/4" | 6.4 | 17/64 | 10453 | 8006 | 890 | 4.06 - 12.07 | 2.01 | 16.76 | 26.90 | 25.40 |
|-------------|--|------|-------|------|-----|-------|-------|------|-----|--------------|------|-------|-------|-------|

ALL PRICES ARE GST EXCLUSIVE. A 10% GST APPLIES

STRUCTURAL FASTENERS

MAGNA-GRIP LOCKBOLT

MADE IN THE USA



Fastener Specifications and Grip Data

| FASTENER CODE | PRICE PER 100 \$ | A | B | DIA INCH MM | DRILL SIZE | TYPICAL IN SHEAR | INSTALLED VALUES | | | GRIP RANGE MM | C | D | a Ref | d Ref |
|---------------|------------------|---|---|-------------|------------|------------------|------------------|---------|-------|---------------|---|---|-------|-------|
| | | | | | | | NOMINAL GRIP N | TENSILE | CLAMP | | | | | |

Button Head - MGPB

STEEL

| | | | | | | | | | | | | | |
|--------------|--|---------|-----------|-----------|-------|-------|-------|-------|---------------|-----------|-------|---------|-----------|
| MGPB-R6-10G | | 4.6-4.7 | 9.04-10.0 | 3/16" 4.8 | 13/64 | 7670 | 6230 | 4110 | 1.57 - 15.88 | 2.87-3.18 | 45.42 | 4.8-4.9 | 2.6-3.1 |
| MGPB-R6-20G | | 4.6-4.7 | 9.04-10.0 | 3/16" 4.8 | 13/64 | 7670 | 6230 | 4110 | 7.92 - 31.75 | 2.87-3.18 | 60.20 | 4.8-4.9 | 7.7-8.1 |
| MGPB-R8-10G | | 6.2-6.3 | 12.0-13.3 | 1/4" 6.4 | 17/64 | 9790 | 11340 | 5340 | 1.57 - 15.88 | 3.45-3.86 | 49.91 | 6.3-6.5 | 2.7-3.5 |
| MGPB-R8-20G | | 6.2-6.3 | 12.0-13.3 | 1/4" 6.4 | 17/64 | 9790 | 11340 | 5340 | 7.92 - 31.75 | 3.45-3.86 | 65.02 | 6.3-6.5 | 7.4-8.3 |
| MGPB-R10-12G | | 7.8-7.9 | 15.0-16.6 | 5/16" 7.9 | 8.0 | 13340 | 17390 | 9560 | 3.18 - 19.05 | 4.60-5.11 | 59.44 | 6.9-7.1 | 6.38Max |
| MGPB-R12-14G | | 9.3-9.5 | 18.1-19.9 | 3/8" 9.5 | 25/64 | 18680 | 25020 | 14230 | 3.18 - 22.23 | 5.66-6.30 | 73.03 | 9.6-9.8 | 4.3-5.1 |
| MGPB-R12-26G | | 9.3-9.5 | 18.1-19.9 | 3/8" 9.5 | 25/64 | 18680 | 25020 | 14230 | 20.62 - 41.28 | 5.66-6.30 | 88.90 | 9.6-9.8 | 20.1-20.9 |

ALUMINIUM

| | | | | | | | | | | | | | |
|-------------|--|---------|-----------|----------|-------|-------|-------|-------|--------------|-----------|-------|---------|---------|
| MGPB-E8-10 | | 6.2-6.3 | 12.0-13.3 | 1/4" 6.4 | 17/64 | 4230 | 7210 | 4230 | 1.57 - 15.88 | 3.45-3.86 | 49.91 | 6.3-6.5 | 2.7-3.5 |
| MGPB-E12-14 | | 9.3-9.5 | 18.1-19.9 | 3/8" 9.5 | 25/64 | 13340 | 17790 | 10680 | 3.18 - 22.23 | 5.66-6.30 | 73.03 | 9.6-9.7 | 4.3-5.1 |

Truss Head - MGPT

STEEL

| | | | | | | | | | | | | | |
|-------------|--|---------|-----------|----------|-------|------|-------|------|---------------|-------------|-------|---------|---------|
| MGPT-R8-10G | | 6.2-6.3 | 13.4-15.0 | 1/4" 6.4 | 17/64 | 9790 | 11340 | 5340 | 1.57 - 15.88 | 2.62 - 2.92 | 49.91 | 6.3-6.5 | 2.7-3.5 |
| MGPT-R8-20G | | 6.2-6.3 | 13.4-15.0 | 1/4" 6.4 | 17/64 | 9790 | 11340 | 5340 | 7.92 - 31.75 | 2.62 - 2.92 | 65.02 | 6.3-6.5 | 7.4-8.3 |
| MGPT-R8-32G | | 6.2-6.3 | 13.4-15.0 | 1/4" 6.4 | 17/64 | 9790 | 11340 | 5340 | 26.97 - 50.80 | 2.62 - 2.92 | 85.70 | 6.3-6.5 | 7.4-8.3 |

Broad Truss Head - MGP30

STEEL

| | | | | | | | | | | | | | |
|---------------|--|---------|-----------|----------|-------|-------|-------|-------|--------------|-------------|-------|---------|-----------|
| MGP30-R8-10G | | 6.2-6.3 | 23.8 | 1/4" 6.4 | 17/64 | 9790 | 11340 | 5340 | 3.96 - 15.88 | 3.51 - 4.11 | 49.91 | 6.3-6.5 | 2.7-3.5 |
| MGP30-R8-24G | | 6.2-6.3 | 23.8 | 1/4" 6.4 | 17/64 | 9790 | 11340 | 5340 | 15.88 - 38.1 | 3.51 - 4.11 | 71.37 | 6.3-6.5 | 13.8-14.6 |
| MGP30-R12-24G | | 9.3-9.5 | 30.1-31.7 | 3/8" 9.5 | 25.64 | 18680 | 25020 | 14230 | 15.88 - 38.1 | 4.78 - 5.38 | 85.73 | 9.6-9.7 | 16.8-17.6 |

Rivet Head - MGP98T

STEEL

| | | | | | | | | | | | | | |
|---------------|--|---------|-------------|-----------|-------|------|------|------|--------------|-----------|-------|---------|---------|
| MGP98T-R6-10G | | 4.6-4.7 | 11.43-12.40 | 3/16" 4.8 | 13/64 | 7670 | 6230 | 4110 | 1.57 - 15.88 | 2.31-2.67 | 45.42 | 4.8-4.9 | 1.9-2.4 |
| MGP98T-R6-20G | | 4.6-4.7 | 11.43-12.40 | 3/16" 4.8 | 13/64 | 7670 | 6230 | 4110 | 7.92 - 31.75 | 2.31-2.67 | 60.20 | 4.8-4.9 | 7.7-8.1 |

ALUMINIUM

| | | | | | | | | | | | | | |
|---------------|--|---------|-------------|-----------|-------|------|------|------|--------------|-----------|-------|---------|---------|
| MGP98T-E6-10G | | 4.6-4.7 | 11.43-12.40 | 3/16" 4.8 | 13/64 | 3340 | 4000 | 2450 | 1.57 - 15.88 | 2.31-2.67 | 45.42 | 4.8-4.9 | 1.9-2.4 |
| MGP98T-E6-20G | | 4.6-4.7 | 11.43-12.40 | 3/16" 4.8 | 13/64 | 3340 | 4000 | 2450 | 7.92 - 31.75 | 2.31-2.67 | 60.20 | 4.8-4.9 | 7.7-8.1 |

90 Countersunk Head - MGP90

STEEL

| | | | | | | | | | | | | | |
|--------------|--|---------|-------------|-----------|-------|------|-------|------|--------------|-----------|-------|---------|---------|
| MGP90-R6-10G | | 4.6-4.7 | 8.20-9.12 | 3/16" 4.8 | 13/64 | 7670 | 6230 | 4110 | 1.57 - 15.88 | 2.34-2.59 | 45.42 | 4.8-4.9 | 8.9 Max |
| MGP90-R8-10G | | 6.2-6.3 | 11.43-12.40 | 1/4" 6.4 | 17/64 | 9790 | 11340 | 5340 | 1.57 - 15.88 | 3.02-3.25 | 49.91 | 5.5-5.7 | 9.6 Max |

ALUMINIUM

| | | | | | | | | | | | | | |
|-------------|--|---------|-----------|-----------|-------|------|------|------|--------------|-----------|-------|---------|---------|
| MGP90-E6-10 | | 4.6-4.7 | 8.20-9.12 | 3/16" 4.8 | 13/64 | 3340 | 4000 | 2450 | 1.57 - 15.88 | 2.34-2.59 | 45.42 | 4.8-4.9 | 8.9 Max |
|-------------|--|---------|-----------|-----------|-------|------|------|------|--------------|-----------|-------|---------|---------|

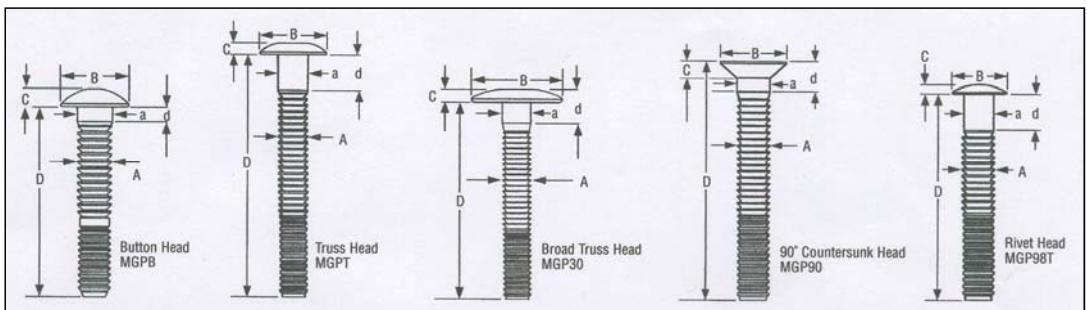

ALL PRICES ARE GST EXCLUSIVE. A 10% GST APPLIES

STRUCTURAL FASTENERS

MAGNA-GRIP COLLARS

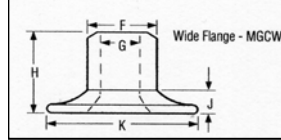
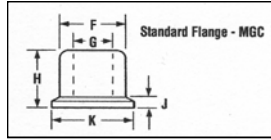

| COLLAR CODE | PRICE PER 100 | COL TYPE | MATERIAL | DIA INCH | F | G | H | J | K |
|-------------|---------------|----------|----------|----------|-------------|-----------|---------------|-------------|---------------|
| MGC-R6U | | Standard | STEEL | 3/16" | 7.85 - 7.92 | 4.83-4.93 | 6.86 - 7.11 | 1.07 - 1.27 | 9.35 - 9.70 |
| MGC-F6 | | Standard | ALUM | 3/16" | 7.85 - 7.92 | 4.83-4.93 | 6.86 - 7.11 | 1.07 - 1.27 | 9.35 - 9.70 |
| MGCW-R6U | | Wide | STEEL | 3/16" | 7.80 - 7.98 | 4.67-5.00 | 7.82 - 9.09 | 1.98 - 2.97 | 16.26 - 19.38 |
| MGCW-F6 | | Wide | ALUM | 3/16" | 7.80 - 7.98 | 4.67-5.00 | 7.82 - 9.09 | 1.98 - 2.97 | 16.26 - 19.38 |
| MGC-R8U | | Standard | STEEL | 1/4" | 10.24-10.31 | 6.40-6.48 | 9.40 - 9.65 | 1.45 - 1.70 | 12.45 - 12.95 |
| MGCW-R8U | | Wide | STEEL | 1/4" | 10.24-10.41 | 6.40-6.48 | 10.97 - 11.73 | 2.92 - 3.68 | 21.72 - 25.40 |
| MGC-F8 | | Standard | ALUM | 1/4" | 10.24-10.31 | 6.40-6.48 | 9.40 - 9.65 | 1.45 - 1.70 | 12.45 - 12.95 |
| MGC-R10U | | Standard | STEEL | 5/16" | 12.78-12.88 | 7.98-8.08 | 10.97 - 11.28 | 1.80 - 2.13 | 15.54 - 16.18 |
| MGC-R12U | | Standard | STEEL | 3/8" | 15.37-15.47 | 9.60-9.70 | 12.70 - 12.95 | 2.24 - 2.49 | 18.80 - 19.30 |
| MGC-F12 | | Standard | ALUM | 3/8" | 15.37-15.47 | 9.60-9.70 | 12.70 - 12.95 | 2.24 - 2.49 | 18.80 - 19.30 |

HUCK INSTALLATION TOOL - LH224

CAN INSTALL THE FOLLOWING FASTENERS WITH CORRECT NOSE ASSEMBLY

| TYPE | DIAMETER | NOSE ASSEMBLY CODE | LIST PRICE |
|---------------|--------------|--------------------|------------|
| MAGNA-LOK | 3/16" | 99-3300 | |
| | 1/4" | 99-3301 | |
| | 3/16" & 1/4" | 99-3487A | |
| MAGNA-BULB | 3/16" | 99-3300 | |
| | 1/4" | 99-3301 | |
| MAGNA-GRIP | 3/16" | 99-3201 | |
| | 1/4" | 99-3204 | |
| HUCKTAINER | 3/8" | 99-3465 | |
| C6L HUCKBOLTS | 3/16" | 99-999 | |
| | 1/4" | 99-1000 | |



Without nose assembly

HUCK INSTALLATION TOOL - 256

CAN INSTALL THE FOLLOWING FASTENERS WITH CORRECT NOSE ASSEMBLY

| TYPE | DIAMETER | NOSE ASSEMBLY CODE | LIST PRICE EACH |
|---------------|----------|--------------------|-----------------|
| MAGNA-LOK | 3/8" | 99-3318 | |
| MAGNA-GRIP | 5/16" | 99-1439 | |
| | 3/8" | 99-1440 | |
| BOM | 3/16" | 99-1053 | |
| | 1/4" | 99-830-1 | |
| | 5/16" | 99-769 | |
| C6L HUCKBOLTS | 5/16" | 99-99 | |
| | 1/4" | 99-100 | |



Without nose assembly

ALL PRICES ARE GST EXCLUSIVE. A 10% GST APPLIES

STRUCTURAL FASTENER

S



CAMTAINER®

Low Profile, Steel Nut and Bolt
TORX® Drive Flanged Nut.

Material
Nut and Bolt: Low carbon steel to SAE 1022
Seal: Thermoplastic elastomer (Kraton)

Finish
Nut and Bolt: Zinc plated
and JS600 passivated

Performance Data

The strength of the joints will vary with the thickness and hardness of the metal sheet of the application as well as with the quality of the GRP board.

| Fastener Size (nom.) | Shear (kN) | Tension (kN) |
|----------------------|------------|--------------|
| 8.0 (5/16") | 14.23 | 20.91 |

Also available in 6 mm and other lengths

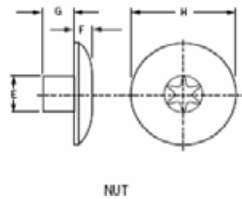
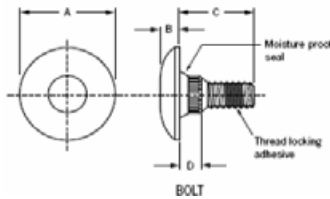

BOLT
A = Head Diameter
B = Head Thickness
C = Length from Underhead
D = Underhead to Knot

NUT
E = Shank Diameter
F = Head Thickness
G = Underhead Shank
H = Head Diameter

| BOLT CODE | DESCRIPTION | P/N | BOLT LENGTH | LIST PRICE PER 100 | NUT CODE | DESCRIPTION NUT | MIN GRIP MM | MAX GRIP MM | PRICE PER 100 |
|-----------|------------------------|--------------|-------------|--------------------|----------|-----------------|-------------|-------------|---------------|
| CAMBOLTB | BOLT BLACK SEAL | 880-82920-29 | 22.22MM | | CAMNUTS | "G" Length | | | |
| | Straight spline groves | | | | | SHORT 12.7MM | 19.94 | 25.78 | |
| CAMBOLTR | BOLT RED SEAL | 880-82920-29 | 25.02MM | | CAMNUTS | SHORT 12.7MM | 25.40 | 29.72 | |
| | Angled spline groves | | | | | CAMNUTL | LONG 25.4MM | 32.13 | 44.07 |
| CAMBOLTW | BOLT WHITE SEAL | 880-84160-29 | 31.37MM | | CAMNUTS | SHORT 12.7MM | 31.75 | 36.35 | |
| | Angled spline groves | | | | | CAMNUTL | LONG 25.4MM | 36.32 | 49.40 |

| Hole size (Nom.) | A | B | D | E | F | H |
|------------------|----------|---------|---------|---------|---------|----------|
| 10.3 mm | 23.11 mm | 5.08 mm | 5.59 mm | 9.91 mm | 4.19 mm | 25.65 mm |

HUCKTAINER LOCKBOLT

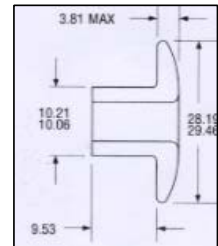
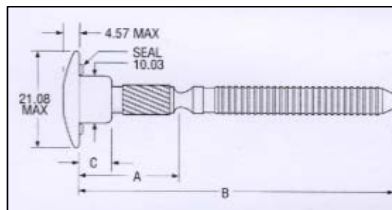

A fastener specifically designed for the commercial vehicle body building industry where G.R.P (glass reinforced plastic) boards are used. This fastener covers a wide grip range, is T.I.R approved, gives improved security to commercial vehicles and has excellent cosmetic appearance qualities.

HUCKTAINER PIN LOW PROFILE - STEEL

| FASTENER CODE | LIST PRICE PER 100 \$ | A | B | DIA MM | DRILL SIZE | C | D | GRIP RANGE MM |
|---------------|-----------------------|-------|-------|--------|------------|-------|-------|---------------|
| HLPP-R12-12 | | 19.02 | 59.87 | 10.03 | 10.5 | 5.59 | 4.01 | 17.45 - 20.62 |
| HLPP-R12-16 | | 25.37 | 66.22 | 10.03 | 10.5 | 11.94 | 10.36 | 23.80 - 26.97 |
| HLPP-R12-18 | | 28.55 | 69.39 | 10.03 | 10.5 | 15.11 | 13.54 | 26.97 - 30.15 |
| HLPP-R12-20 | | 31.72 | 72.57 | 10.03 | 10.5 | 18.29 | 16.71 | 30.15 - 33.32 |

HUCKTAINER COLLAR WIDE BEARING - STEEL

| COLLAR LIST PRICE PER 100 |
|---------------------------|
| HLPS-R12 |
| |
| |
| |

MAGNA-BULB STEEL

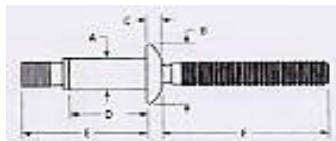

| FASTENER CODE | LIST PRICE PER 100 \$ | A | B | DIA INCH MM | DRILL SIZE | TYPICAL IN SHEAR | INSTALLED VALUES NOMINAL GRIP N TENSILE | PIN RET | GRIP RANGE MM | C | D | E | F |
|---------------|-----------------------|------|-------|-------------|------------|------------------|---|---------|---------------|------|-------|-------|-------|
| MBP-R8-M4 | | 6.38 | 13.46 | 1/4" 6.4 | 17/64 | 16010 | 8900 | 1334 | 3.81 - 5.82 | 3.18 | 13.77 | 23.19 | 27.94 |
| MBP-R8-M5 | | 6.38 | 13.46 | 1/4" 6.4 | 17/64 | 16010 | 8900 | 1334 | 4.80 - 6.81 | 3.18 | 14.76 | 23.88 | 27.94 |
| MBP-R8-M6 | | 6.38 | 13.46 | 1/4" 6.4 | 17/64 | 16010 | 8900 | 1334 | 5.82 - 7.82 | 3.18 | 15.77 | 25.40 | 27.94 |
| MBP-R8-M7 | | 6.38 | 13.46 | 1/4" 6.4 | 17/64 | 16010 | 8900 | 1334 | 6.81 - 8.79 | 3.18 | 16.76 | 26.42 | 27.94 |
| MBP-R8-M8 | | 6.38 | 13.46 | 1/4" 6.4 | 17/64 | 16010 | 8900 | 1334 | 7.82 - 9.83 | 3.18 | 17.78 | 27.43 | 27.94 |
| MBP-R8-M9 | | 6.38 | 13.46 | 1/4" 6.4 | 17/64 | 16010 | 8900 | 1334 | 8.79 - 10.80 | 3.18 | 18.77 | 28.45 | 27.94 |
| MBP-R8-M10 | | 6.38 | 13.46 | 1/4" 6.4 | 17/64 | 16010 | 8900 | 1334 | 9.83 - 11.84 | 3.18 | 19.79 | 29.46 | 27.94 |
| MBP-R8-M11 | | 6.38 | 13.46 | 1/4" 6.4 | 17/64 | 16010 | 8900 | 1334 | 10.8 - 12.8 | 3.18 | 20.78 | 30.48 | 27.94 |