

BSW MILD 4.6 STEEL HEX HEAD BOLTS AND NUTS ZINC PLATED



List Price Per 100

DIAMETER	1/4"	5/16"	3/8"	1/2"
LENGTH				
3/4	✓	✓	✓	
1	✓	✓	✓	✓
1.1/4	✓	✓	✓	✓
1.1/2	✓	✓	✓	✓
1.3/4	✓	✓	✓	✓
2	✓	✓	✓	✓
2.1/4	✓	✓	✓	✓
2.1/2	✓	✓	✓	✓
3	✓	✓	✓	✓
3.1/2	✓	✓	✓	✓
4	✓	✓	✓	✓
4.1/2	✓	✓	✓	✓
5	✓	✓	✓	✓
6	✓	✓	✓	✓

BSW CLASS 4.6 HEX SET SCREWS ZINC PLATED

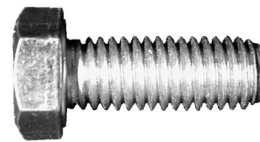

List Price Per 100

DIAMETER	1/4"	5/16"	3/8"	1/2"	5/8"
LENGTH					
1/2	✓	✓			
3/4	✓	✓	✓	✓	
1	✓	✓	✓	✓	
1.1/4	✓	✓	✓	✓	
1.1/2	✓	✓	✓	✓	✓
2	✓	✓	✓	✓	✓
2.1/2	✓	✓	✓	✓	✓
3	✓	✓	✓	✓	✓
3.1/2			✓		
4			✓	✓	✓

METRIC CLASS 4.6 PURLIN BOLTS & NUTS ZINC PLATED



List Price Per 100

Purlin Bolt Assembly With 2 Washers			Purlin Bolt Flanged		
DIAMETER	M12	CODE	DIAMETER	M12	CODE
LENGTH			LENGTH		
30	✓	PURLINBOLT1230	30	✓	PURLINFLAN1230

METRIC CLASS 4.6 HEX HEAD BOLTS & NUTS ZINC PLATED



List Price Per 100

DIAMETER	M6-1.0	M8-1.25	M10-1.5	M12-1.75	M16-2.0	M20-2.50
LENGTH						
MM						
20	✓	✓	✓			
25	✓	✓	✓	✓	✓	
30	✓	✓	✓	✓	✓	
35	✓	✓	✓	✓	✓	✓
40	✓	✓	✓	✓	✓	✓
45	✓	✓	✓	✓	✓	✓
50	✓	✓	✓	✓	✓	✓
55	✓	✓	✓	✓	✓	✓
60	✓	✓	✓	✓	✓	✓
65	✓	✓	✓	✓	✓	✓
70	✓	✓	✓	✓	✓	✓
75	✓	✓	✓	✓	✓	✓
80	✓	✓	✓	✓	✓	✓
90	✓	✓	✓	✓	✓	✓
100	✓	✓				
120	✓	✓				
130	✓	✓				
140	✓	✓				
150	✓	✓				

METRIC CLASS 4.6 HEX HEAD SET SCREWS ZINC PLATED - Metric Coarse Thread

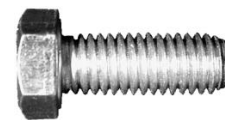

List Price Per 100

DIAMETER	M4	M5	M6	M8	M10	M12	M16
LENGTH							
10	✓		✓				
12	✓		✓	✓	✓		
16	✓		✓	✓	✓		
✓	✓		✓	✓	✓	✓	
25	✓		✓	✓	✓	✓	
30	✓		✓	✓	✓	✓	✓
35	✓		✓	✓	✓	✓	✓
✓	✓		✓	✓	✓	✓	✓
50	✓		✓	✓	✓	✓	✓
60			✓	✓	✓	✓	✓
65			✓	✓	✓	✓	✓
75			✓	✓	✓	✓	✓
100				✓	✓	✓	✓

HIGH TENSILE

METRIC COARSE HEX HEAD BOLTS ONLY CLASS 8.8

ZINC PLATED

List Price Per 100



DIAMETER	M6-1.0	M8-1.25	M10-1.5	M12-1.75	M14-2.0	M16-2.0
LENGTH						
MM						
25	✓	✓	✓	✓	✓	✓
30	✓	✓	✓	✓	✓	✓
35	✓	✓	✓	✓		✓
40	✓	✓	✓	✓	✓	✓
45	✓	✓	✓	✓	✓	✓
50	✓	✓	✓	✓	✓	✓
55	✓	✓	✓	✓	✓	✓
60	✓	✓	✓	✓	✓	✓
65	✓	✓	✓	✓	✓	✓
70	✓	✓	✓	✓	✓	✓
75	✓	✓	✓	✓	✓	✓
80	✓	✓	✓	✓	✓	✓
90		✓	✓	✓	✓	✓
100		✓	✓	✓	✓	✓
110		✓	✓	✓		✓
120		✓	✓	✓	✓	✓
130		✓	✓	✓		✓
140			✓	✓		✓

HIGH TENSILE

METRIC HEX HEAD SET SCREWS CLASS 8.8

ZINC PLATED - Metric Coarse Thread

List Price Per 100



DIAMETER	M6-1.0	M8-1.25	M10-1.5	M12-1.75	M16-2.0
LENGTH					
12	✓	✓			
16	✓	✓	✓		
20	✓	✓	✓	✓	
25	✓	✓	✓	✓	✓
30	✓	✓	✓	✓	✓
35	✓	✓	✓	✓	✓
40	✓	✓	✓	✓	✓
50	✓	✓	✓	✓	✓
60		✓		✓	✓
65		✓	✓	✓	✓
70		✓	✓	✓	✓
75		✓	✓	✓	✓
80			✓	✓	✓
90					✓
100		✓	✓	✓	✓

HIGH TENSILE
METRIC HEX HEAD SET SCREWS/HEX BOLT CLASS 10.9
ZINC PLATED - Metric Coarse Thread



List Price Per 100

SET SCREWS			HEX BOLTS	
DIAMETER	M10-1.5	M12-1.75	DIAMETER	M12-1.25
LENGTH			LENGTH	
25	✓	✓	75	✓
30	✓	✓	90	✓
40	✓	✓	100	✓
75	✓	✓		
90	✓			

HIGH TENSILE
METRIC HEX STRUCTURAL ASSEMBLIES BOLTS, NUTS & WASHERS
GAL - GRADE 8.8



List Price Per 100

DIAMETER	M16-2.0	M20-2.5
LENGTH		
40	✓	✓
45	✓	✓
50	✓	✓
55	✓	✓
60	✓	✓
65	✓	✓
75	✓	✓
80	✓	✓
100	✓	✓
110	✓	✓

HEX COACH SCREWS



List Price Per 100

10mm DIAMETER		
LENGTH	GALV	ZINC
MM		
40	✓	✓
50	✓	✓
65	✓	✓
75	✓	✓
90	✓	✓
100	✓	✓
120	✓	✓
130	✓	✓
150	✓	✓

12mm DIAMETER		
LENGTH	GALV	ZINC
MM		
40	✓	
50	✓	✓
75	✓	✓
90	✓	✓
100	✓	✓
120	✓	
130	✓	✓
150	✓	✓
200	✓	✓

METRIC CUP HEAD BOLTS & NUTS



List Price Per 100

DIAMETER MM	LENGTH MM	THREAD LENGTH	Zinc Plated	Galvanised
6 - 1.0	20	Full	✓	✓
	25	Full	✓	✓
	30	Full	✓	✓
	40	30	✓	✓
	50	30	✓	✓
	60	30	✓	✓
	70	50	✓	✓
	75	50	✓	✓
	90	50	✓	✓
	100	75	✓	✓
8 - 1.25	20	Full	✓	✓
	25	Full	✓	✓
	30	Full	✓	✓
	40	30	✓	✓
	50	30	✓	✓
	60	30	✓	✓
	70	50	✓	✓
	90	50	✓	✓
	100	75	✓	✓
	10 - 1.5	25	Full	✓
30		Full	✓	✓
40		Full	✓	✓
50		40	✓	✓
60		40	✓	✓
70		40	✓	✓
85		60	✓	✓
90		60	✓	✓
100		60	✓	✓
110		80	✓	✓
120		80	✓	✓
130		80	✓	✓
140		80	✓	✓
150		80	✓	✓
160		100		✓
170		100	✓	✓
180		100	✓	✓
200		100	✓	✓
240		100		✓
260		100		✓
300	100		✓	
12 - 1.75	30	Full		✓
	40	Full	✓	✓
	50	40	✓	✓
	65	40	✓	✓
	75	40	✓	✓
	85	60		✓
	90	60	✓	✓
	100	60	✓	✓
	110	80		✓
	120	80		✓
	130	80	✓	✓
	150	80	✓	✓
	160	100		✓
	180	100	✓	✓
	200	100	✓	✓
	220	130		✓
	240	130		✓
	260	130		✓
	280	130		✓
	300	150		✓
400	150		✓	





METAL THREAD SCREWS

ZINC PLATED



Pan



CSK

SAMPLE CODE: MTSC1434 = 1/4X3/4 CSK

SAMPLE CODE: MTSMP620 = M6X20 PAN

DIAMETER BSW	LENGTH		DIAMETER METRIC	LENGTH	
1/8	1/4	✓	M3	10	✓
	3/8	✓		12	✓
	1/2	✓		16	✓
	3/4	✓		20	✓
	1	✓		25	✓
5/32	3/8	✓	M4	6	✓
	1/2	✓		10	✓
	5/8	✓		12	✓
	3/4	✓		16	✓
	1	✓		20	✓
3/16	1/4	✓		25	✓
	3/8	✓		30	✓
	1/2	✓		35	✓
	5/8	✓		40	✓
	3/4	✓		50	✓
	1	✓	M5	10	✓
	1.1/4	✓		16	✓
	1.1/2	✓		20	✓
	1.3/4	✓		25	✓
	2	✓		30	✓
1/4	2.1/2	✓	40	✓	
	3	✓	50	✓	
	3/8	✓	M6	10	✓
	1/2	✓		12	✓
	5/8	✓		16	✓
	3/4	✓		20	✓
	1	✓		25	✓
	1.1/4	✓		30	✓
	1.1/2	✓		40	✓
	2	✓		50	✓
2.1/2	✓	65		✓	
3	✓	75		✓	
		M8	16	✓	
			25	✓	
			50	✓	
		M10	25	✓	
			50	✓	

ARS Bolt,Rivet Nut & Washer
For Truck FRP panel and
Hardware.



RB5161CL	5/16 X 1 Roof Bolt Comb With Loctite	✓
3060	5/16 Rivet Nuts Z/Y	✓
WFM112302	11.2X30.0X2.0MM Round Washer Z/F	✓



ROOFING BOLTS ZINC PLATED - Imperial

SAMPLE CODE: RB31634

DIAMETER BSW	LENGTH	
3/16	3/8	✓
	1/2	✓
	3/4	✓
	1	✓
	1.1/4	✓
	1.1/2	✓
	2	✓
	3	✓
1/4	1/2	✓
	3/4	✓
	1	✓
	1.1/4	✓
	1.1/2	✓
	1.3/4	✓
	2	✓
	2.1/2	✓
5/16	3/4	✓
	1	✓
	1.1/4	✓
	2	✓
	2.1/2	✓
	3	✓



HANDLE SCREWS ZINC PLATED

SAMPLE CODE: MTSM420

DIAMETER	LENGTH	
M4	16	✓
	20	✓
	22	✓
	28	✓
	35	✓
	40	✓

ROOFING BOLTS

ZINC PLATED - Metric

SAMPLE CODE: RBM616C

DIAMETER MM	LENGTH MM	
	16	✓
	25	✓
6.0	30	✓
	40	✓

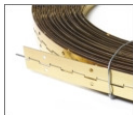

PIANO HINGE

DESCRIPTION	CODE	
Continuous Butt Hinge 32mmx0.7x25m Roll Nickel Plated		
 PIANOHINGENP25		✓
Continuous Butt Hinge Drilled 32mmx1.2x1.8m Length 304 Stainless		
	PIANOHINGESS32	✓

NUTS - TEE FOR WOOD 4 PRONG ZINC PLATED

CODE	SIZE X BARREL LTH	BOX QTY	
BSW			
TN316	18mm X 7.0mm	1000	✓
TN14	18mm X 7.0mm	1000	✓
TN516	22MM X 9.0mm	1000	✓
TN511658	22mm X 16MM	1000	✓
TN38	25mm X 11MM	1000	✓
METRIC			
TN4	15mm X 7.0mm	1000	✓
TN5	15mm X 7.0mm	1000	✓
TN6	18MM X 7.0mm	1000	✓
TN8	22mm X 9.0MM	1000	✓
TN8L	22mm X 16MM	1000	✓
TN10	25mm X 11MM	1000	✓





NUTS - HEXAGON

ZINC PLATED

BSW CODE	SIZE			METRIC CODE	SIZE	
HNB18	1/8	✓		HN3	M3	✓
HNB532	5/32	✓		HN4	M4	✓
HNB316	3/16	✓		HN5	M5	✓
HNB14	1/4	✓		HN6	M6	✓
HNB516	5/16	✓		HN8	M8	✓
HNB38	3/8	✓		HN10	M10	✓
HNB12	1/2	✓		HN12	M12	✓
HNB58	5/8	✓		HN16	M16	✓
HNB34	3/4	✓		HN20	M20	✓



NUTS - NYLON INSERT

LOCK NUTS

SIZE						
	UNC	UNF	METRIC	CLASS6	CLASS8	CLASS10
3/16	✓		M3	✓	✓	
1/4	✓	✓	M4	✓	✓	
5/16	✓	✓	M5	✓	✓	
3/8	✓	✓	M6	✓	✓	
7/16	✓		M8	✓	✓	✓
1/2	✓	✓	M10	✓	✓	✓
9/16	N/A	✓	M12	✓	✓	✓
5/8	✓	✓	M16	✓	✓	✓
3/4	✓	✓	M20	✓	✓	✓
7/8	✓	✓	M24	✓	✓	✓
1	✓	POA				



NUTS - DOME

BRASS - NICKEL PLATED

STAINLESS STEEL 304

BSW CODE	SIZE			METRIC CODE	SIZE	
DNB18	1/8	✓		DNSS4	M4	✓
DNB532	5/32	✓		DNSS5	M5	✓
DNB316	3/16	✓		DNSS6	M6	✓
DNB14	1/4	✓		DNSS8	M8	✓
DNB516	5/16	✓		DNSS10	M10	✓
DNB38	3/8	✓		DNSS12	M12	✓



NUTS - WING

STEEL - ZINC PLATED

FLANGE SERRATED LOCKING

STEEL - ZINC PLATED - CLASS 8

CODE	SIZE			METRIC CODE	SIZE	
WNB14	1/4 BSW	✓		HNF4	M4	✓
WN6	M6	✓		HNF5	M5	✓
WN8	M8	✓		HNF6	M6	✓
WN10	M10	✓		HNF8	M8	✓
WN12	M12	✓		HNF10	M10	✓

METAL THREAD SCREWS PAN & CSK HEAD - Phillips Recess 304 Stainless



CODE	SIZE	FINISH	PACK QTY	
CSK=MTSCSS				
MTSPSS416	M4X16	304	100	✓
MTSPSS420	M4X20	304	100	✓
MTSPSS425	M4X25	304	100	✓
MTSPSS430	M4X30	304	100	✓
MTSPSS612	M6X12	304	100	✓
MTSPSS616	M6X16	304	100	✓
MTSPSS620	M6X20	304	100	✓
MTSPSS625	M6X25	304	100	✓
MTSPSS630	M6X30	304	100	✓
MTSPSS640	M6X40	304	100	✓
MTSPSS650	M6X50	304	100	✓
MTSPSS820	M8X20	304	100	✓
MTSPSS825	M8X25	304	100	✓
MTSPSS830	M8X30	304	100	✓
MTSPSS840	M8X40	304	100	✓
MTSPSS850	M8X50	304	100	✓





*Also available in imperial sizing

HEX HEAD SET SCREWS & BOLTS - 304 Stainless

HEX SET SCREW

HEX BOLT

CODE	SIZE			CODE	SIZE	
SSSS620	M6X20	✓		XOSSM640	M6X40	✓
SSSS625	M6X25	✓		XOSSM645	M6X45	✓
SSSS630	M6X30	✓		XOSSM650	M6X50	✓
SSSS635	M6X35	✓		XOSSM660	M6X60	✓
SSSS640	M6X40	✓		XOSSM670	M6X70	✓
SSSS645	M6X45	✓		XOSSM680	M6X80	✓
SSSS650	M6X50	✓				
				XOSSM840	M8X40	✓
SSSS816	M8X16	✓		XOSSM845	M8X45	✓
SSSS820	M8X20	✓		XOSSM850	M8X50	✓
SSSS825	M8X25	✓		XOSSM860	M8X60	✓
SSSS830	M8X30	✓		XOSSM870	M8X70	✓
SSSS840	M8X40	✓		XOSSM880	M8X80	✓
SSSS850	M8X50	✓				
SSSS1035	M10X20	✓		XOSSM1040	M10X40	✓
SSSS1040	M10X25	✓		XOSSM1045	M10X45	✓
SSSS1035	M10X35	✓		XOSSM1050	M10X50	✓
SSSS1040	M10X40	✓		XOSSM1060	M10X60	✓
SSSS1045	M10X45	✓		XOSSM1070	M10X70	✓
SSSS1050	M10X50	✓		XOSSM1080	M10X80	✓
SSSS1060	M10X60	✓		XOSSM1090	M10X90	✓
SSSS1070	M10X70	✓		XOSSM10100	M10X100	✓
SSSS1080	M10X80	✓				
				XOSSM1240	M12X40	✓
SSSS1240	M12X25	✓		XOSSM1250	M12X50	✓
SSSS1250	M12X40	✓		XOSSM1260	M12X60	✓
SSSS1260	M12X50	✓		XOSSM1270	M12X70	✓
			XOSSM1280	M12X80	✓	

Hex nuts Imperial & Metric - 304 Stainless

UNC CODE	SIZE			METRIC CODE	SIZE	
HNSSUNC14	1/4	✓		HNSS3	M3	✓
HNSSUNC516	5/16	✓		HNSS4	M4	✓
HNSSUNC38	3/8	✓		HNSS5	M5	✓
HNSSUNC12	1/2	✓		HNSS6	M6	✓
HNSSUNC58	5/8	✓		HNSS8	M8	✓
HNSSUNC34	3/4	✓		HNSS10	M10	✓
				HNSS12	M12	✓
*UNF also available			HNSS16	M16	✓	
			HNSS20	M20	✓	

Nyloc Hex nuts Imperial & Metric - 304 Stainless

UNC CODE	SIZE			METRIC CODE	SIZE	
NNSSUNC14	1/4	✓		NNSS3	M3	✓
NNSSUNC516	5/16	✓		NNSS4	M4	✓
NNSSUNC38	3/8	✓		NNSS5	M5	✓
NNSSUNC12	1/2	✓		NNSS6	M6	✓
NNSSUNC58	5/8	✓		NNSS8	M8	✓
NNSSUNC34	3/4	✓		NNSS10	M10	✓
				NNSS12	M12	✓
*UNF also available			NNSS16	M16	✓	
			NNSS20	M20	✓	

Flat Washers Imperial & Metric - 304 Stainless

IMPERIAL CODE	SIZE			METRIC CODE	SIZE	
WFSS31671620	3/16X7/16X20	✓		WFSS4908	M4X9X0.8	✓
WFSS3161220	3/16X12X20	✓		WFSS51008	M5X10X0.8	✓
WFSS3163418	3/16X3/4X18	✓		WFSS61212	M6X12X1.2	✓
WFSS141220	1/4X12X20	✓		WFSS61816	M6X18X1.6	✓
WFSS143418	1/4X3/4X18	✓		WFSS81712	M8X17X1.2	✓
WFSS14116	1/4X1X16	✓		WFSS102112	M10X21X1.2	✓
WFSS1411416	1/4X1-1/4X16	✓		WFSS122416	M12X24X1.6	✓
WFSS383418	3/8X3/4X18	✓				
WFSS38116	3/8X1X16	✓				
WFSS3411214	3/4X1-1/2X14	✓				

Not all stainless sizes available are listed in our catalogue, for further enquiries please give us a call.

THREADED ROD

MILD STEEL ZINC PLATED



SIZE METRIC	FINISH	PACK SIZE	LGTH 1 METRE	LGTH 3 METRE	CODE Add 1 to end code or 3 lgth
M6	Zinc Plated	20	✓	✓	TR6
M8	Zinc Plated	20	✓	✓	TR8
M10	Zinc Plated	20	✓	✓	TR10
M10	Galvanised	20	✓	✓	TR103G
M12	Zinc Plated	10	✓	✓	TR12
M16	Zinc Plated	10	✓	✓	TR16
M20	Zinc Plated	5	✓	✓	TR20

HEX COUPLING NUT

MILD STEEL CL5 ZINC PLATED



METRIC SIZE	CODE	PACK SIZE	LENGTH MM	
M6	HC6	500	25	✓
M8	HC8	500	24	✓
M10	HC10	250	30	✓
M12	HC12	250	36	✓
M16	HC16	100	50	✓

PURLIN CLAMP

MILD STEEL ZINC PLATED

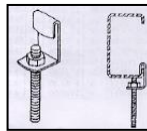

M10 METRIC	PCM10			✓
------------	-------	--	--	---



THREADED ROD CUTTER

M10	NKM10	EA		✓
SPARE JAWS				
For M10	NKS10	EA		✓

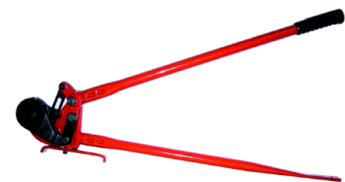

CODE	DESCRIPTION	BOX QTY	
HS30/30	Holistrap 30mm x 30mtr x 0.8mm Roll	EA	✓
FOILFAST	Foil & Shade Cloth Fastener 50 Strips of 10-23x25mm 4 Pin	500	✓

